

Rail x2

Throws

Pitch: .8" each way
Roll: 1" each way

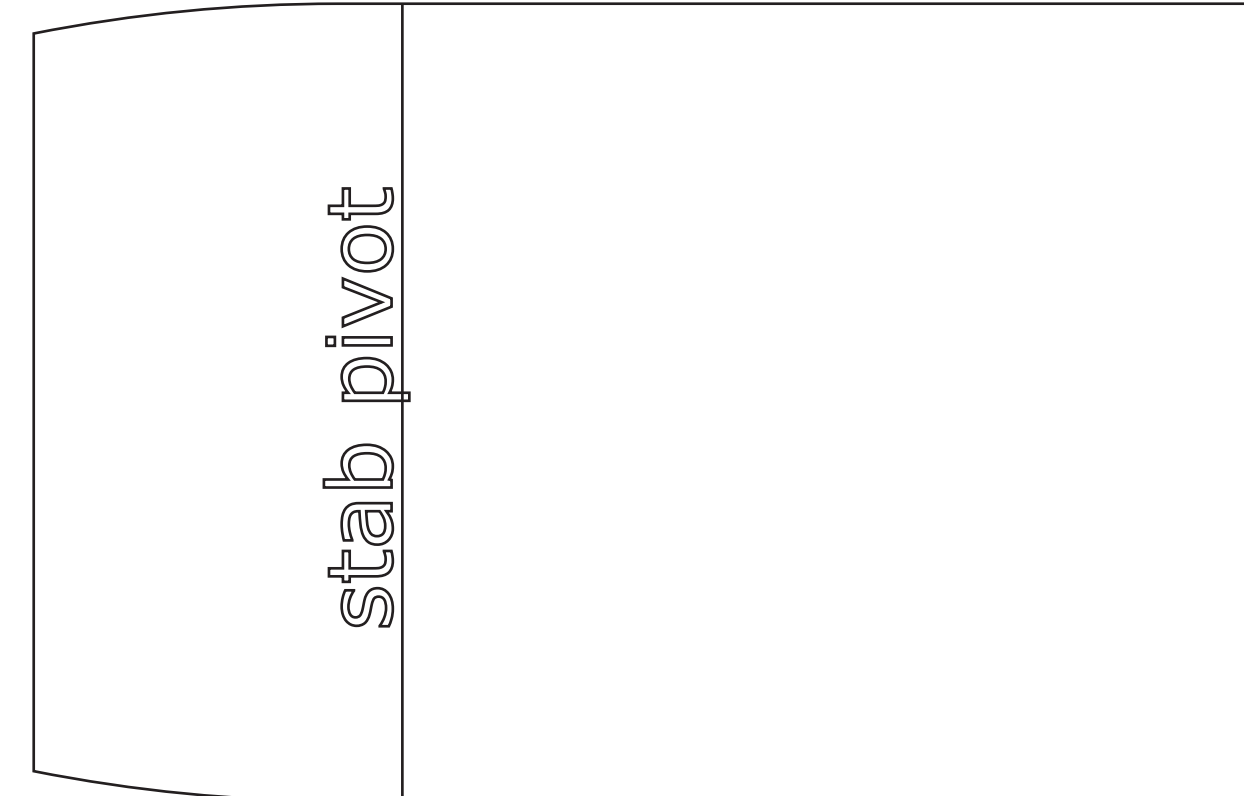

stab pivot

23.60

cf rod spar

cf rod spar

1.5" -1.62"

servo

servo



Vert stab x2



W3

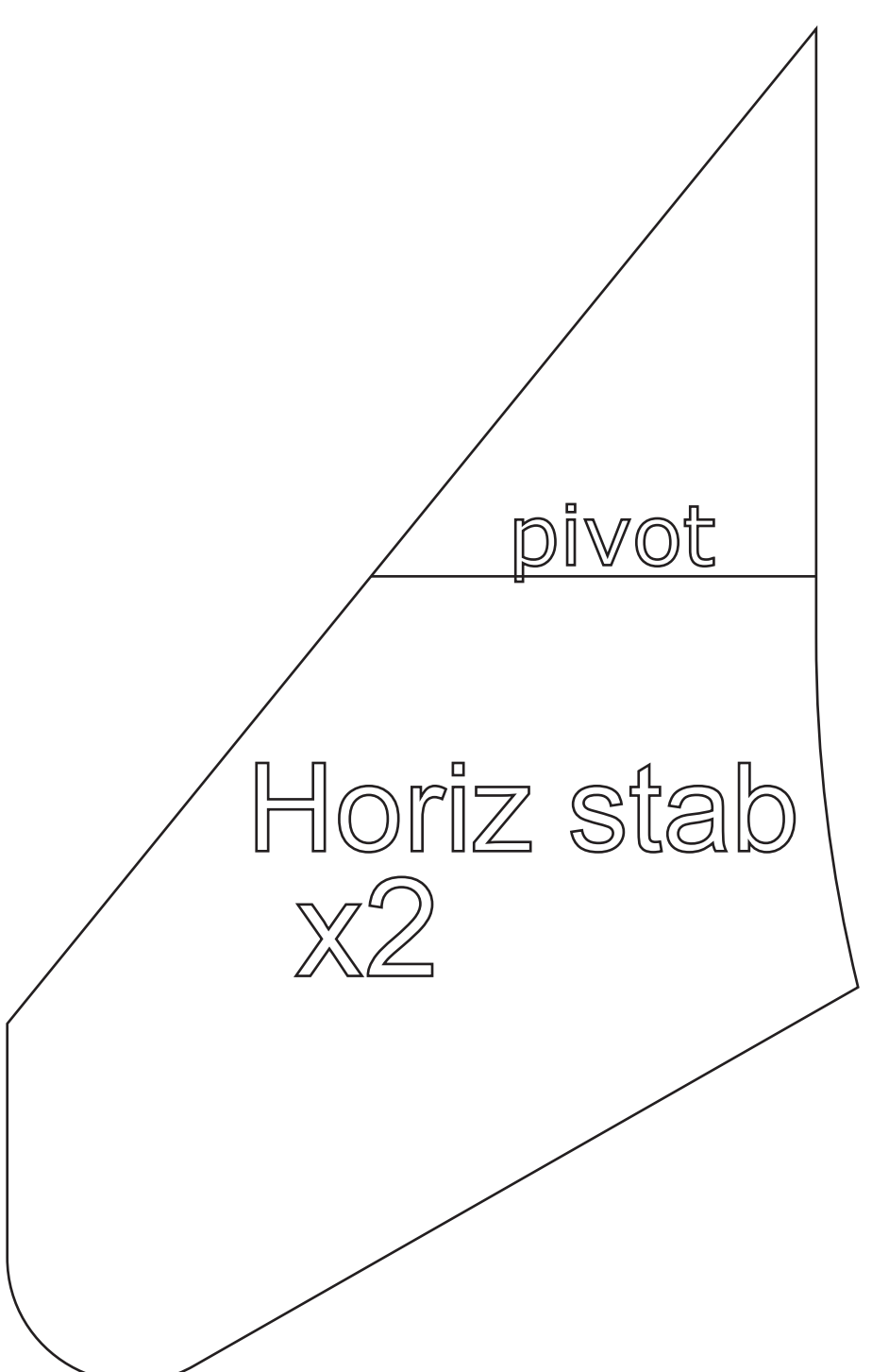

pivot
Horiz stab x2



F2

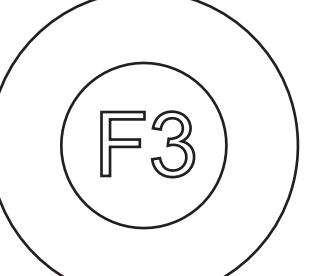

F3

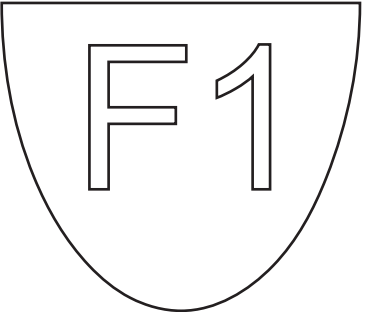

F1



W2

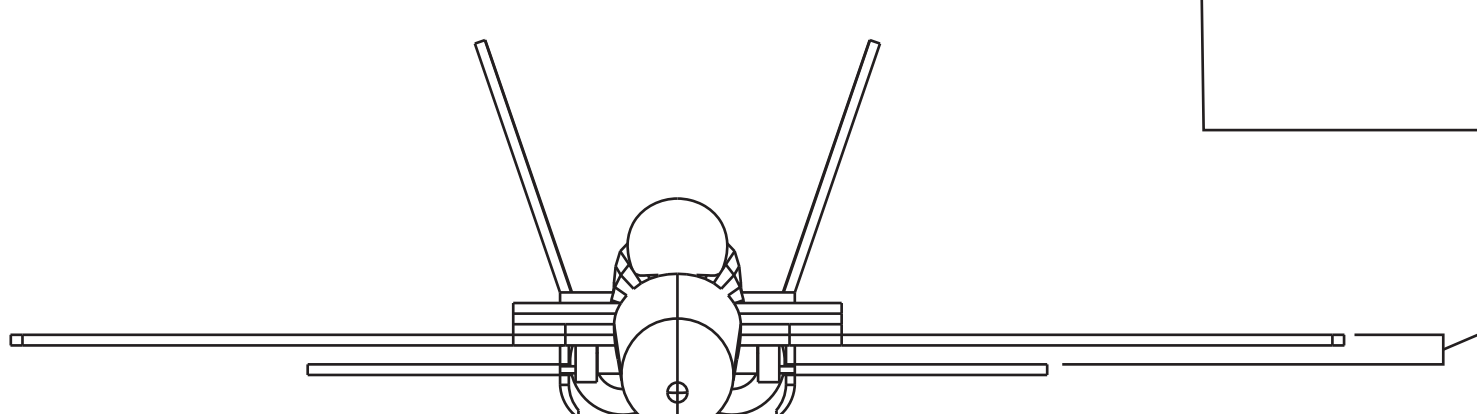

h stab
.52" below wing



W1

f1

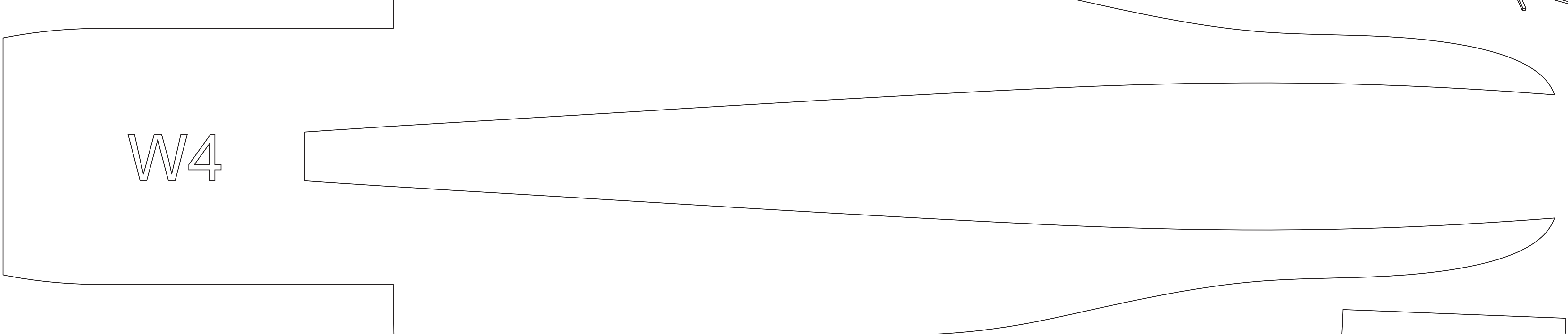

W4

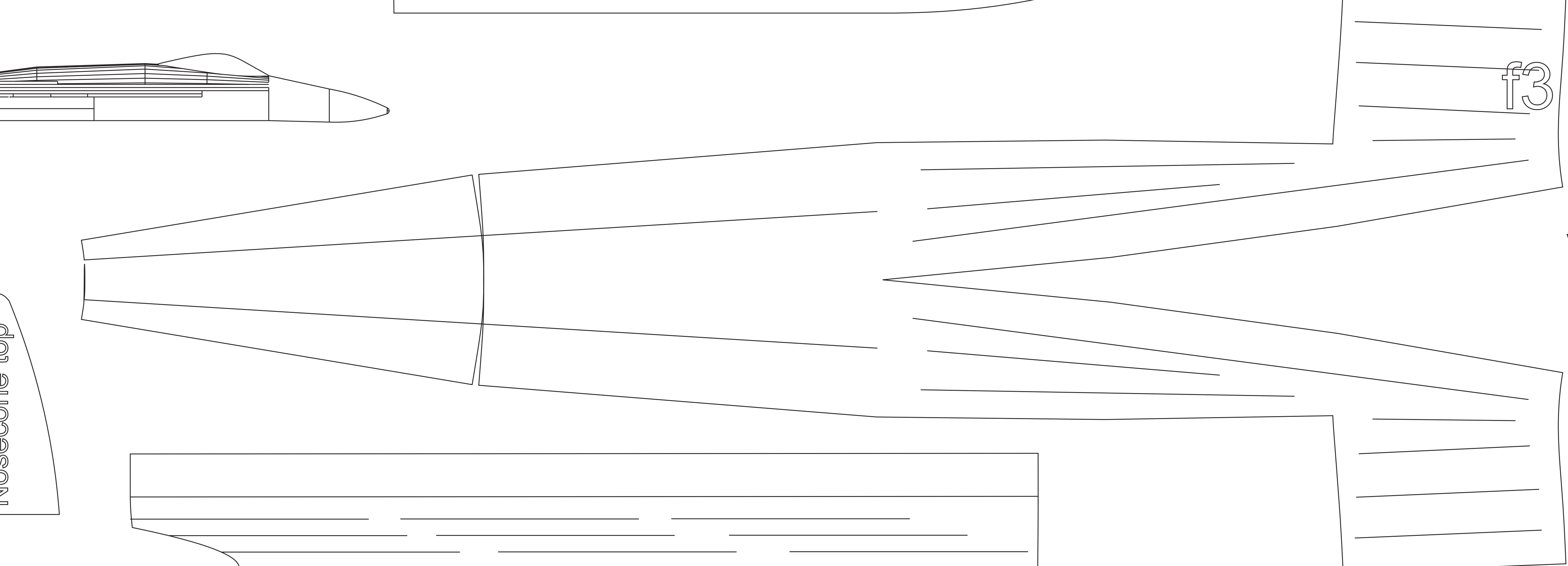
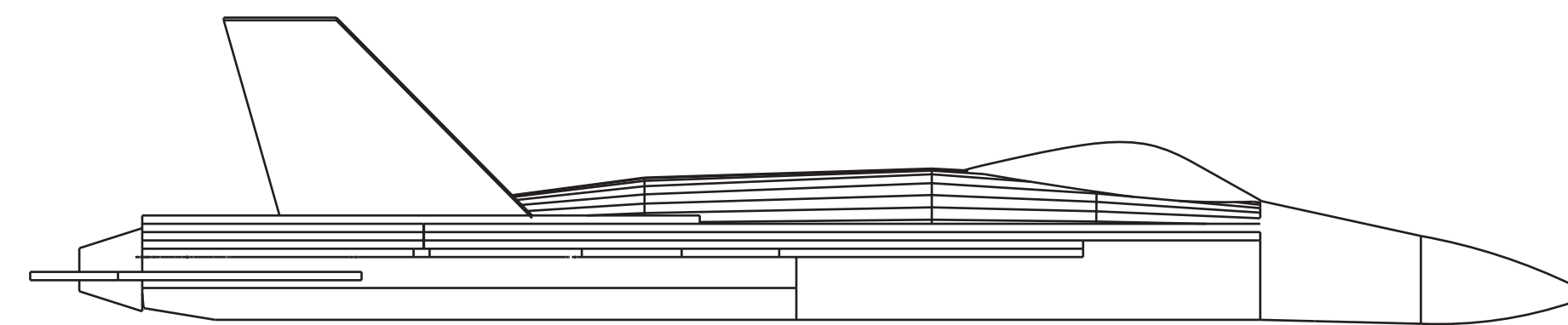
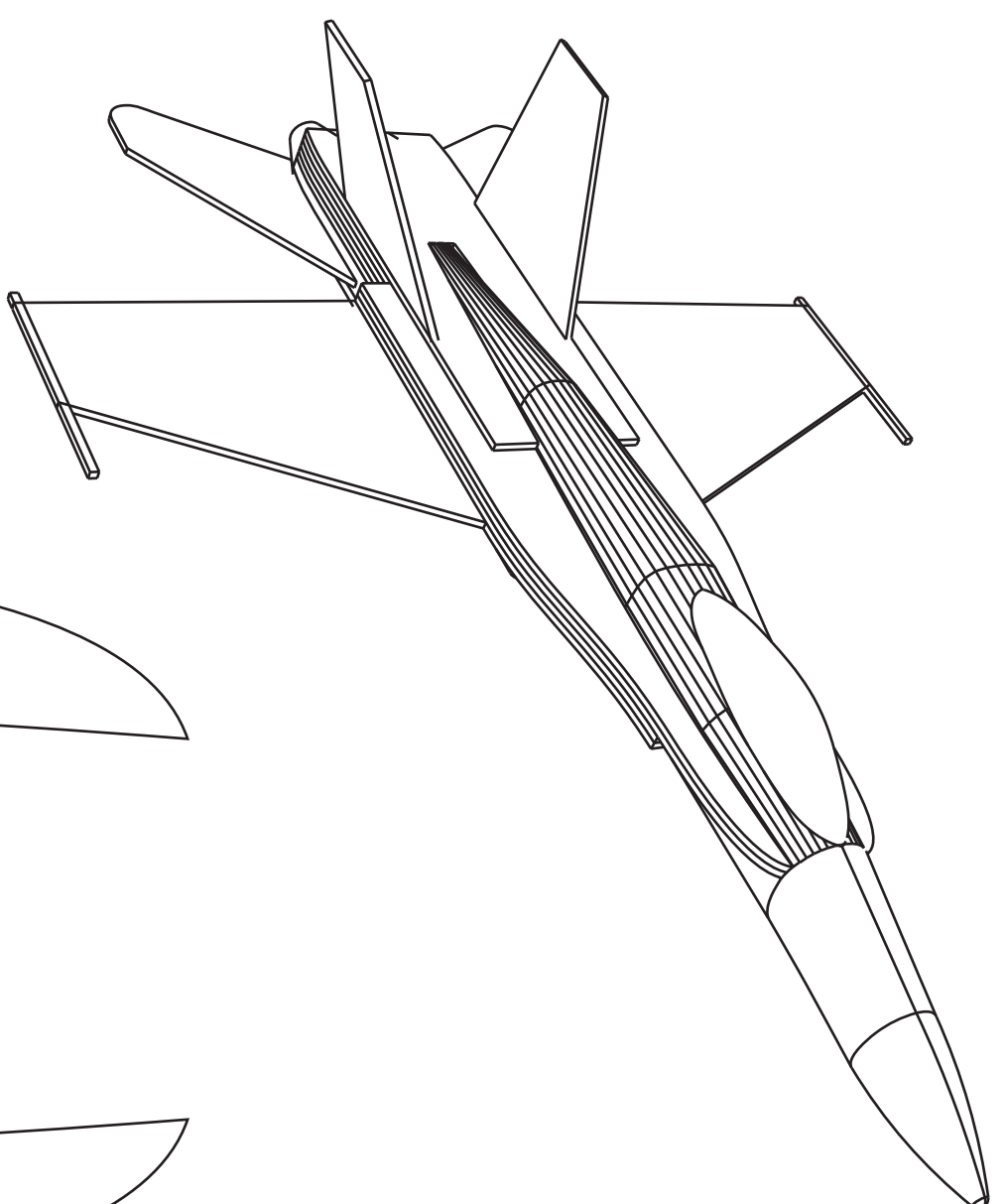

f3

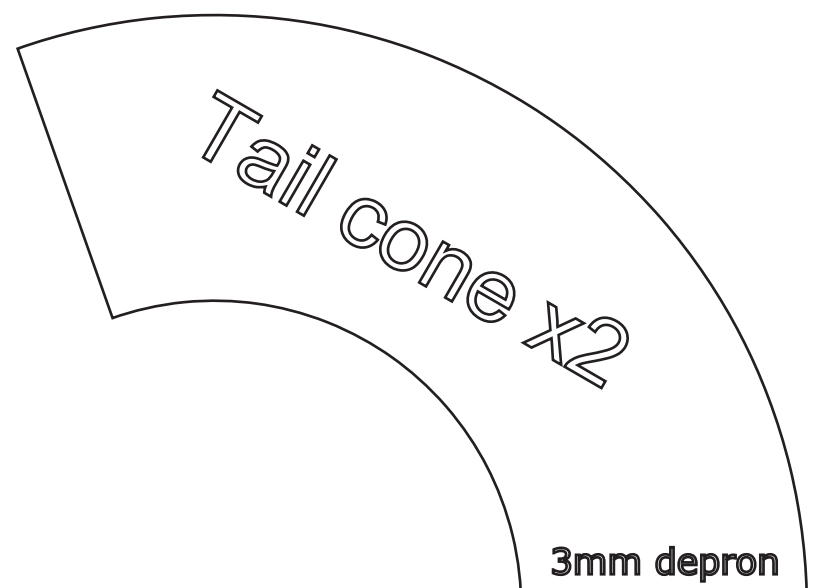

Tail cone x2

3mm depron

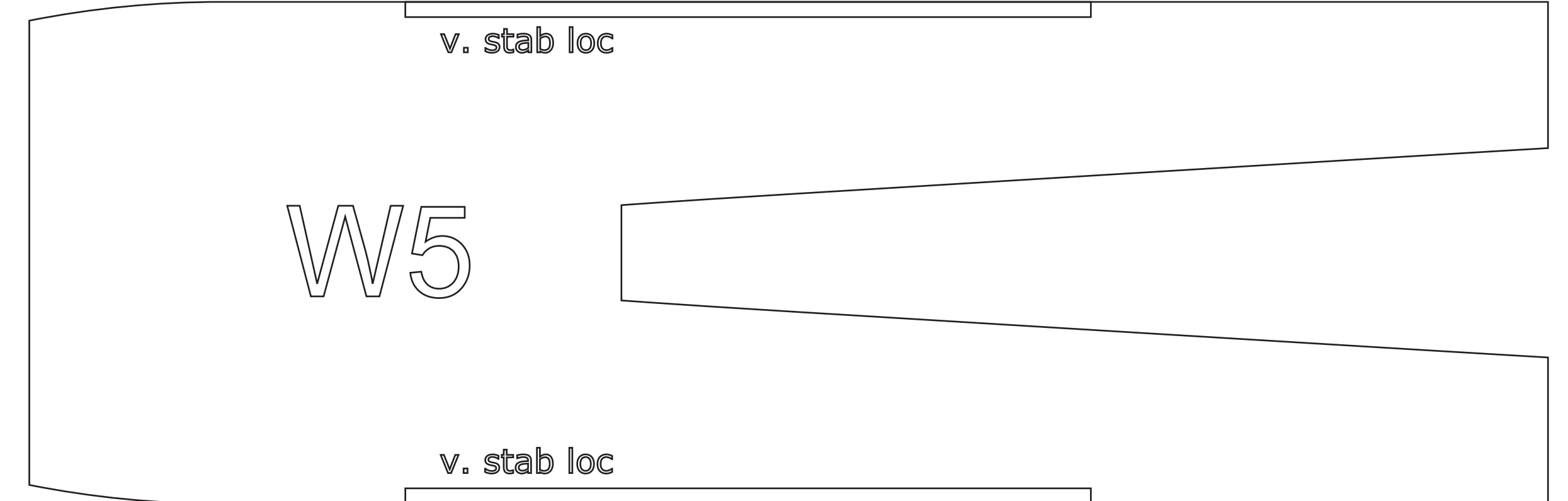

W5

v. stab loc

v. stab loc

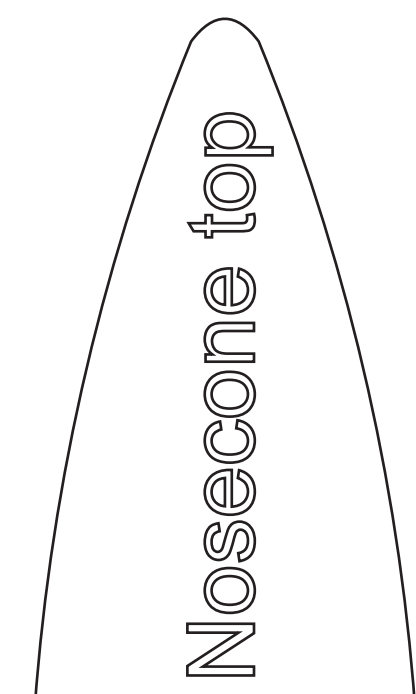

Nosecone top

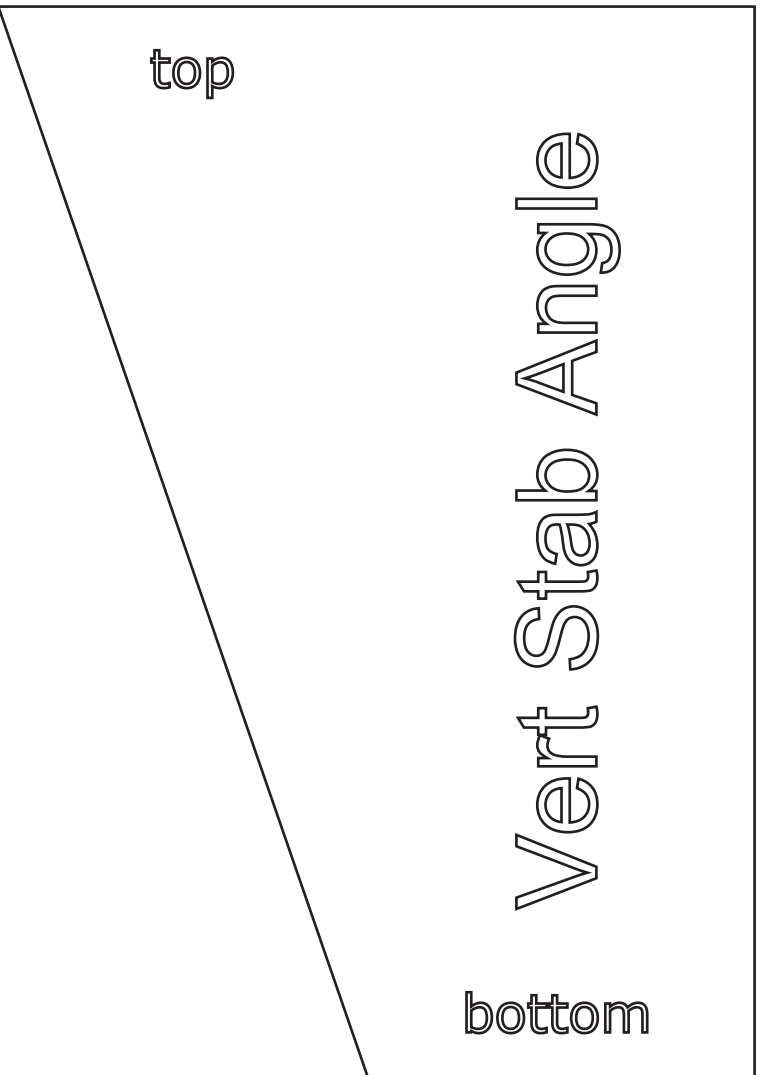

top

Vert Stab Angle

bottom

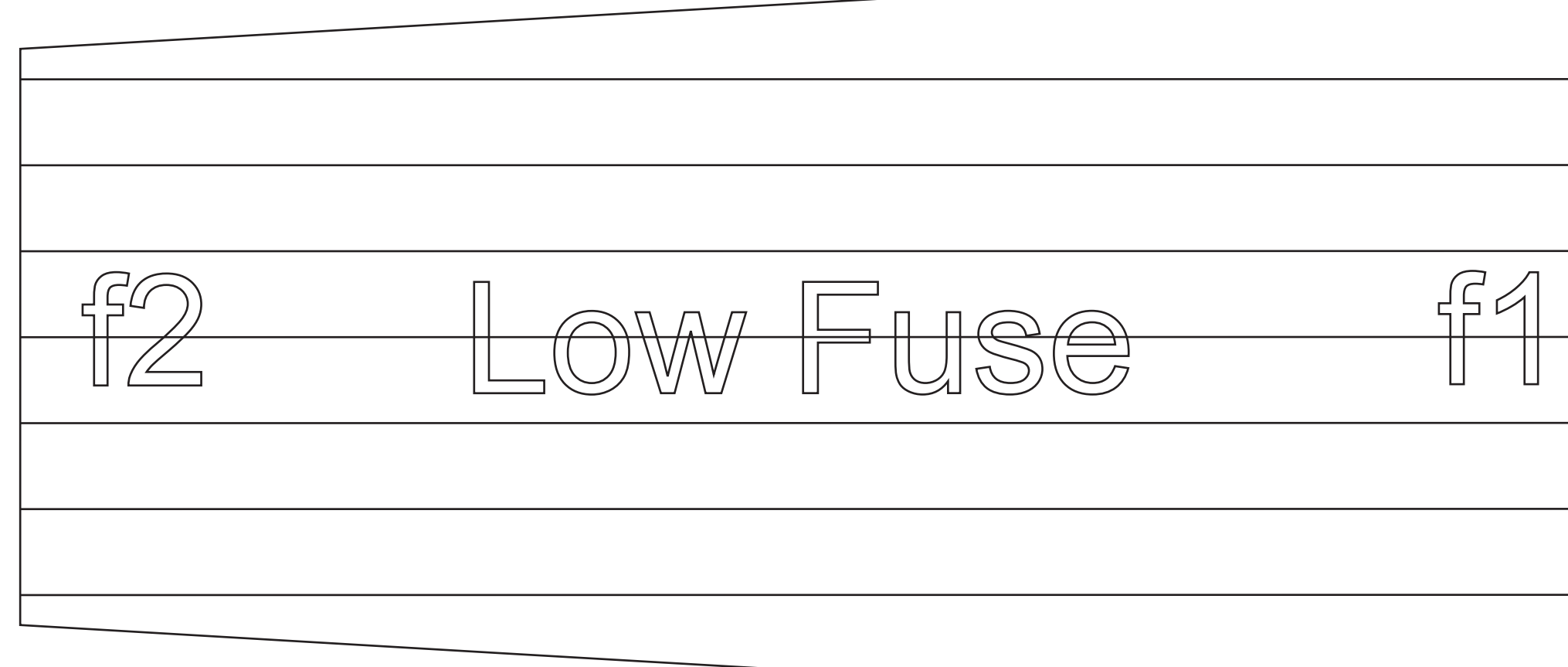

f2

Low Fuse

f1

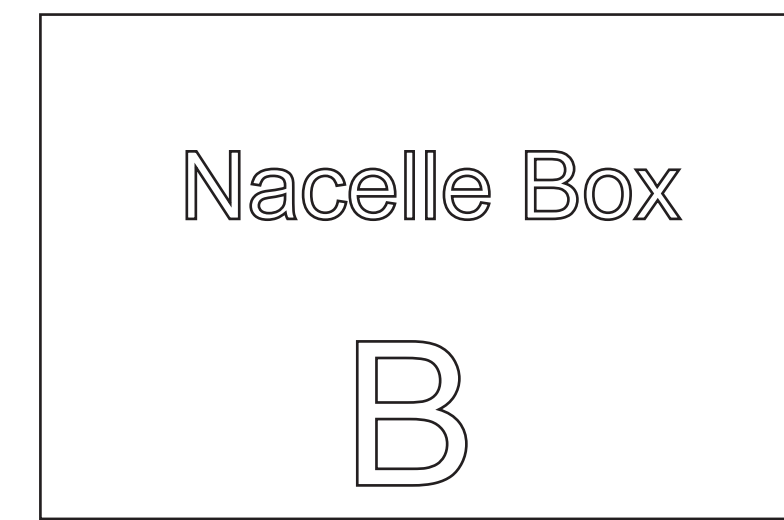

Nacelle Box B

B

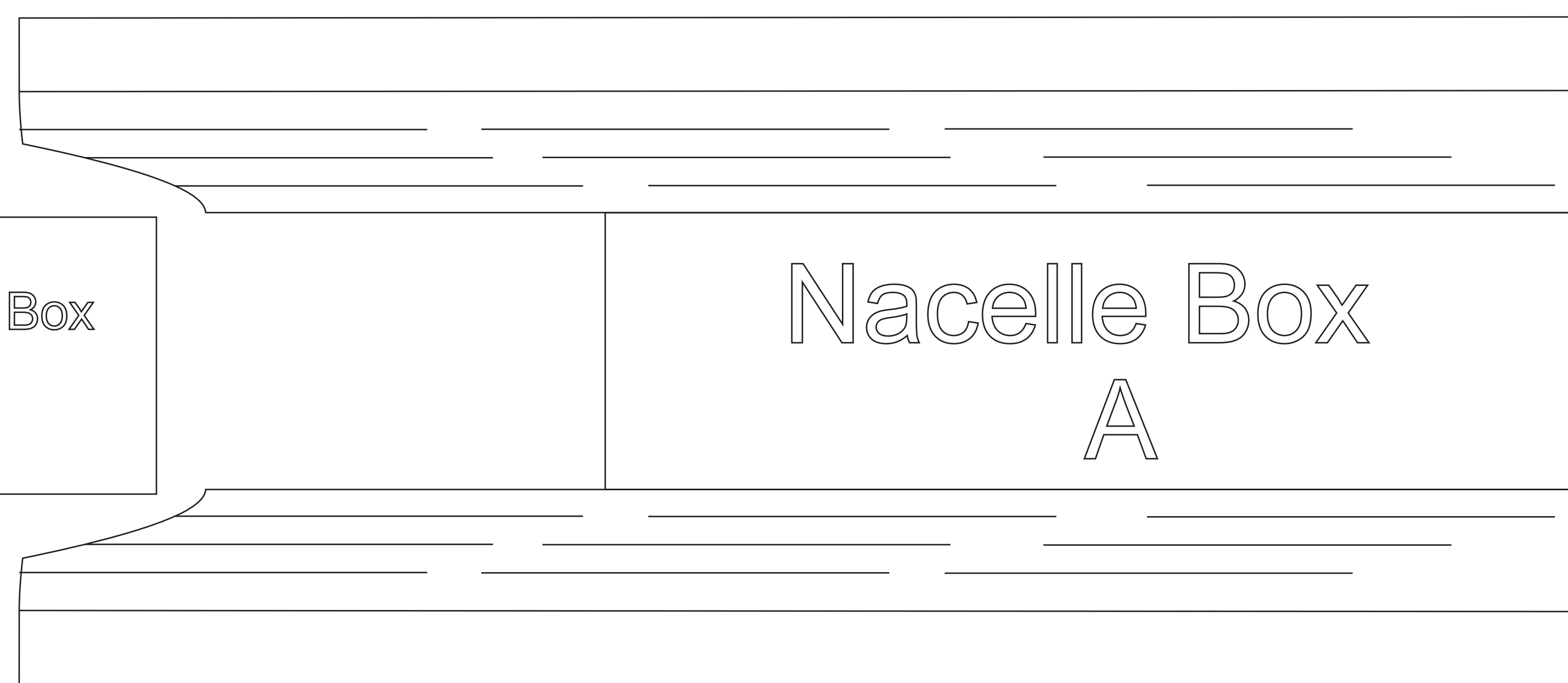

Nacelle Box A

A

MB F/A18 Hornet
 design by Al Sprosta 2004
 scale 1 inch
 for 1/4" - 3/8" Fanfold/Depron

pivot

Horiz stab
 $\times 2$

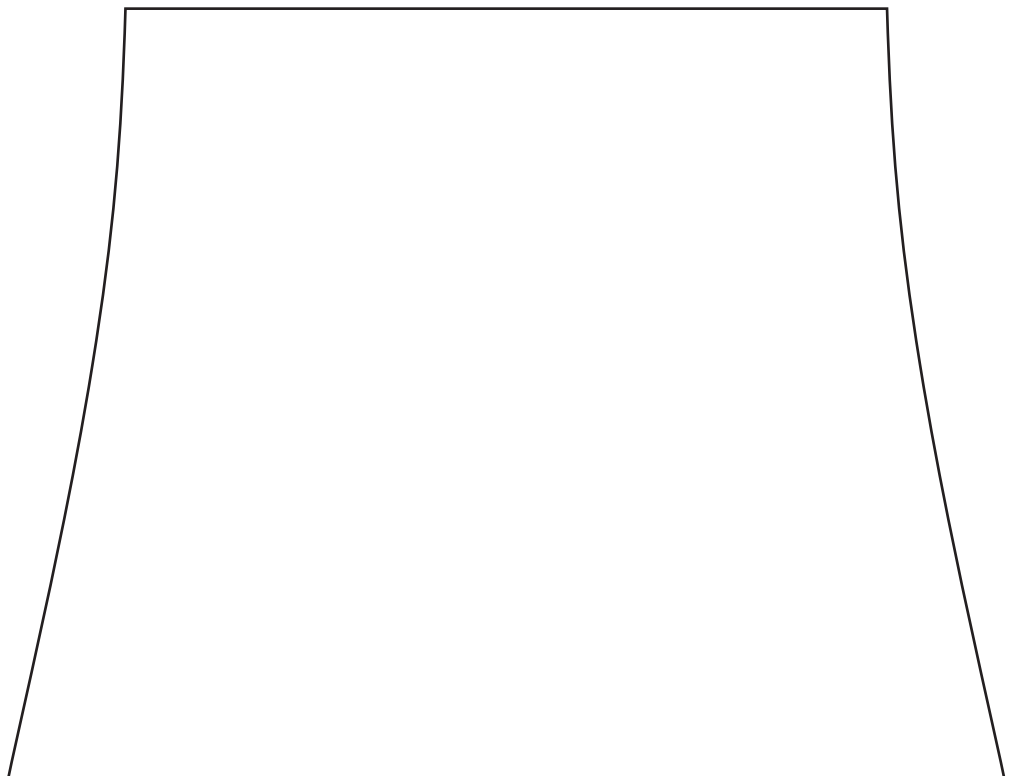
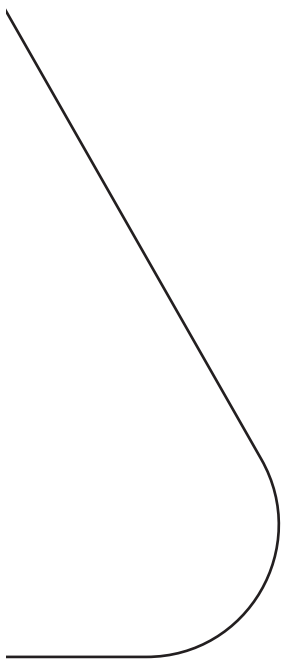

4
11

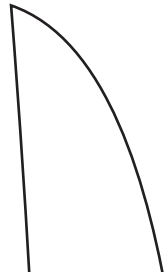
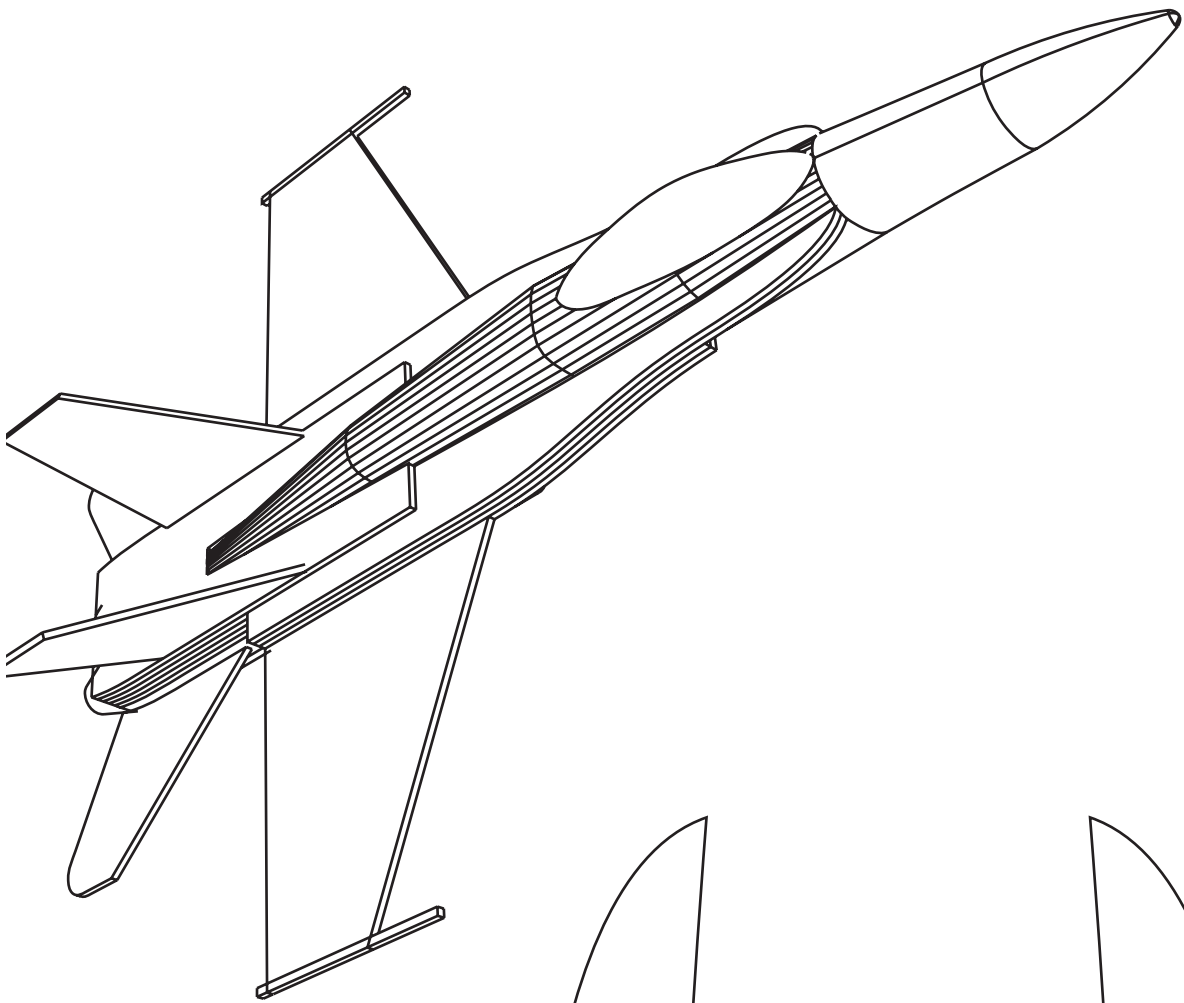

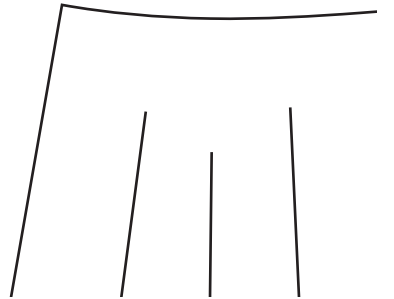
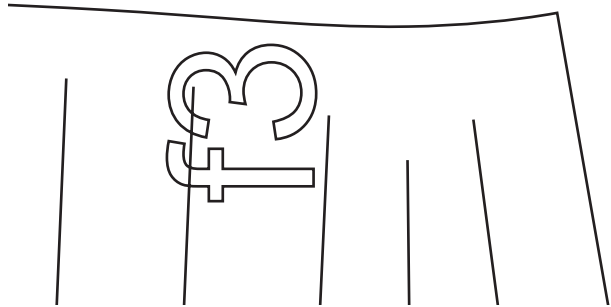
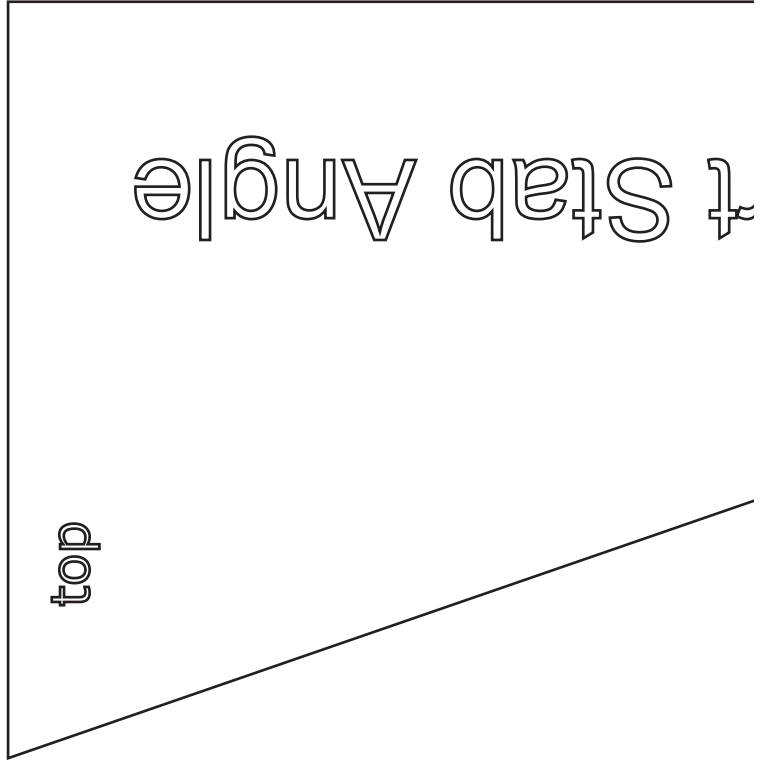
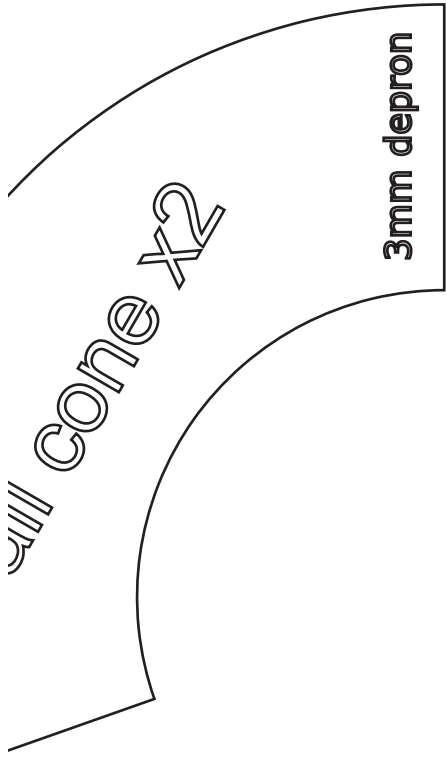

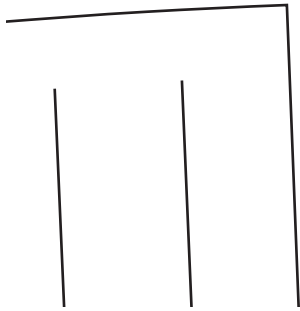

18 Hornet

by Al Sprosta 2004
for 1/4" - 3/8" Fanfold/Depron

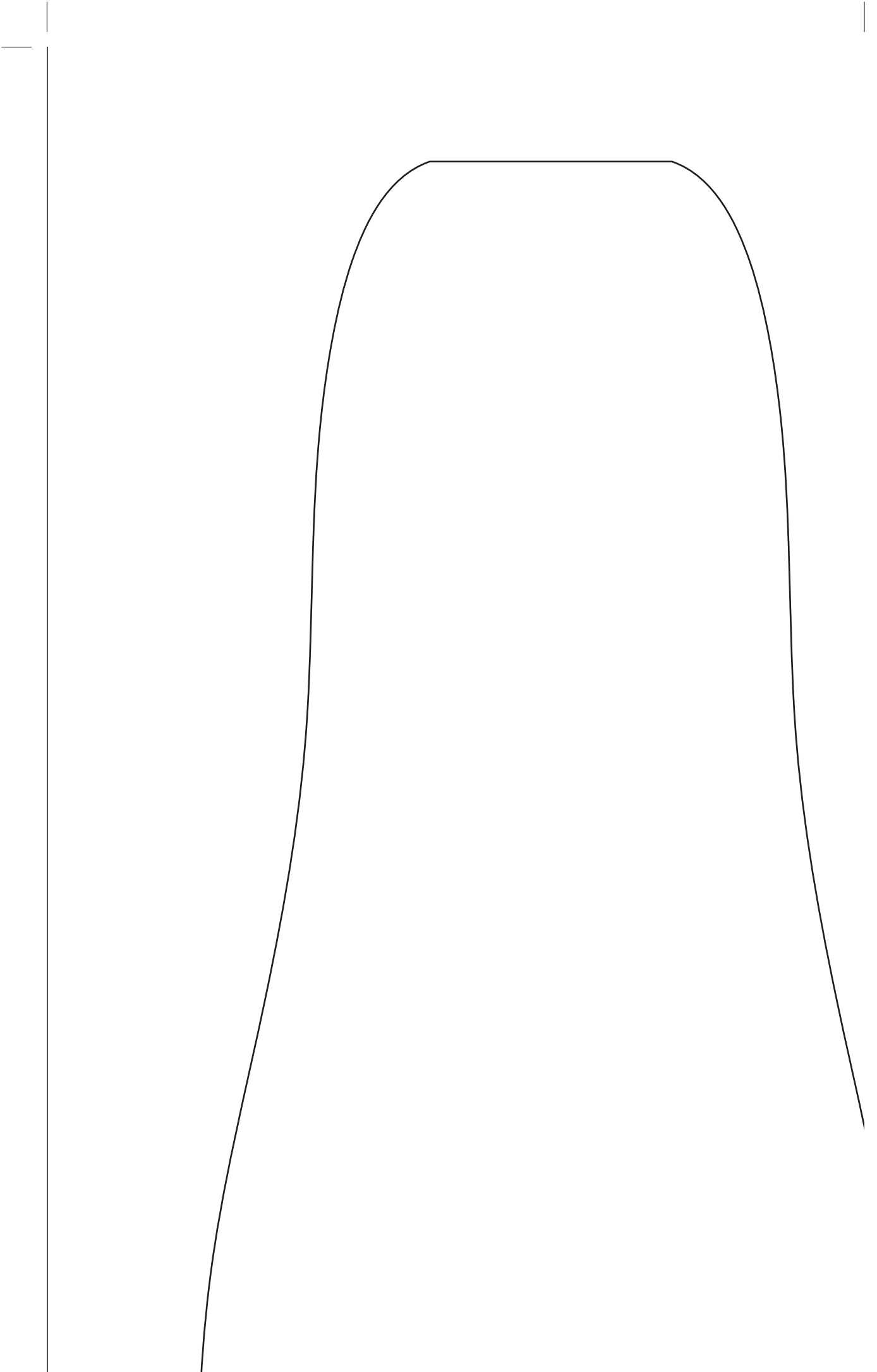

W2

h stab

.52" below wing

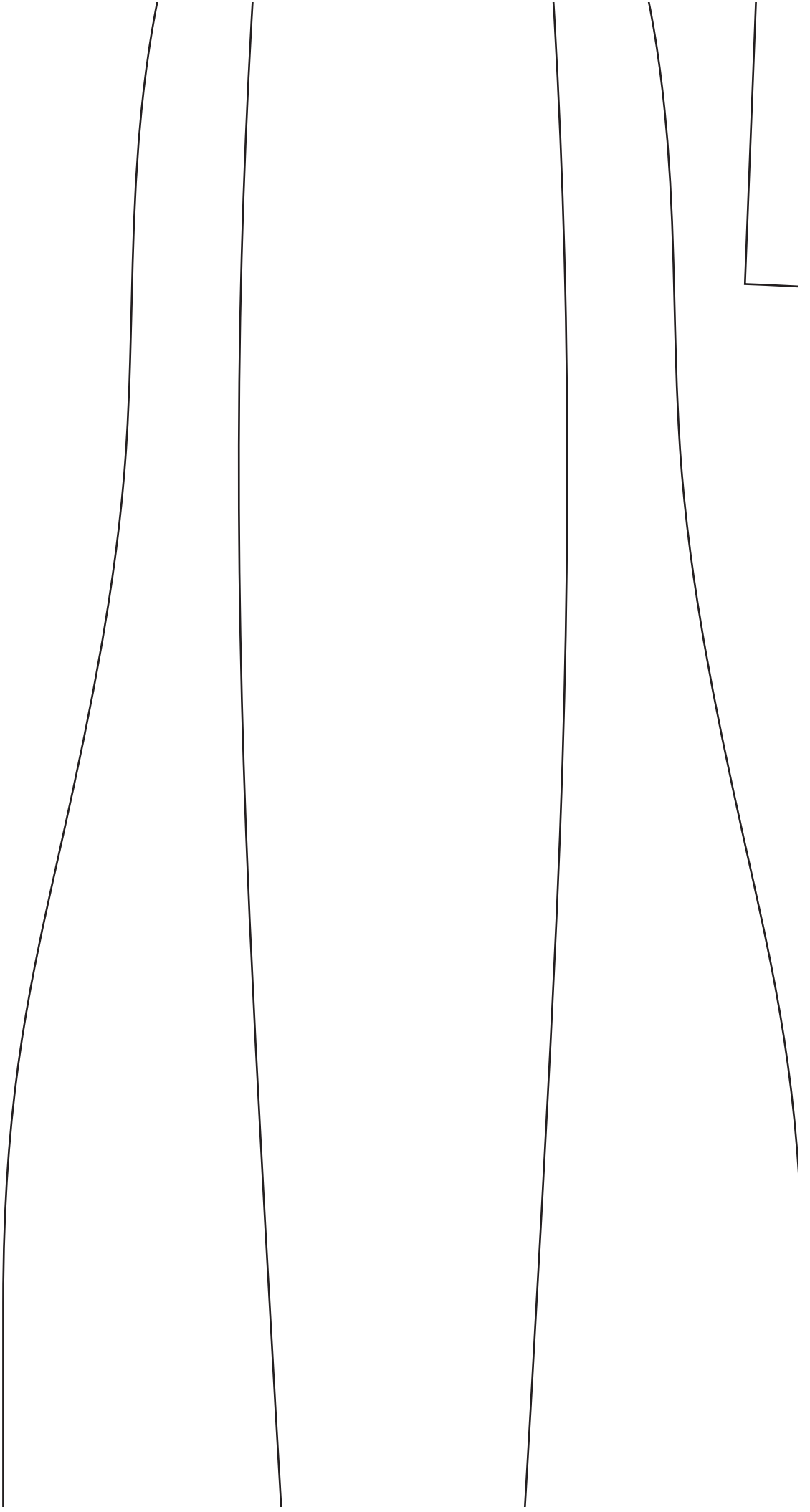

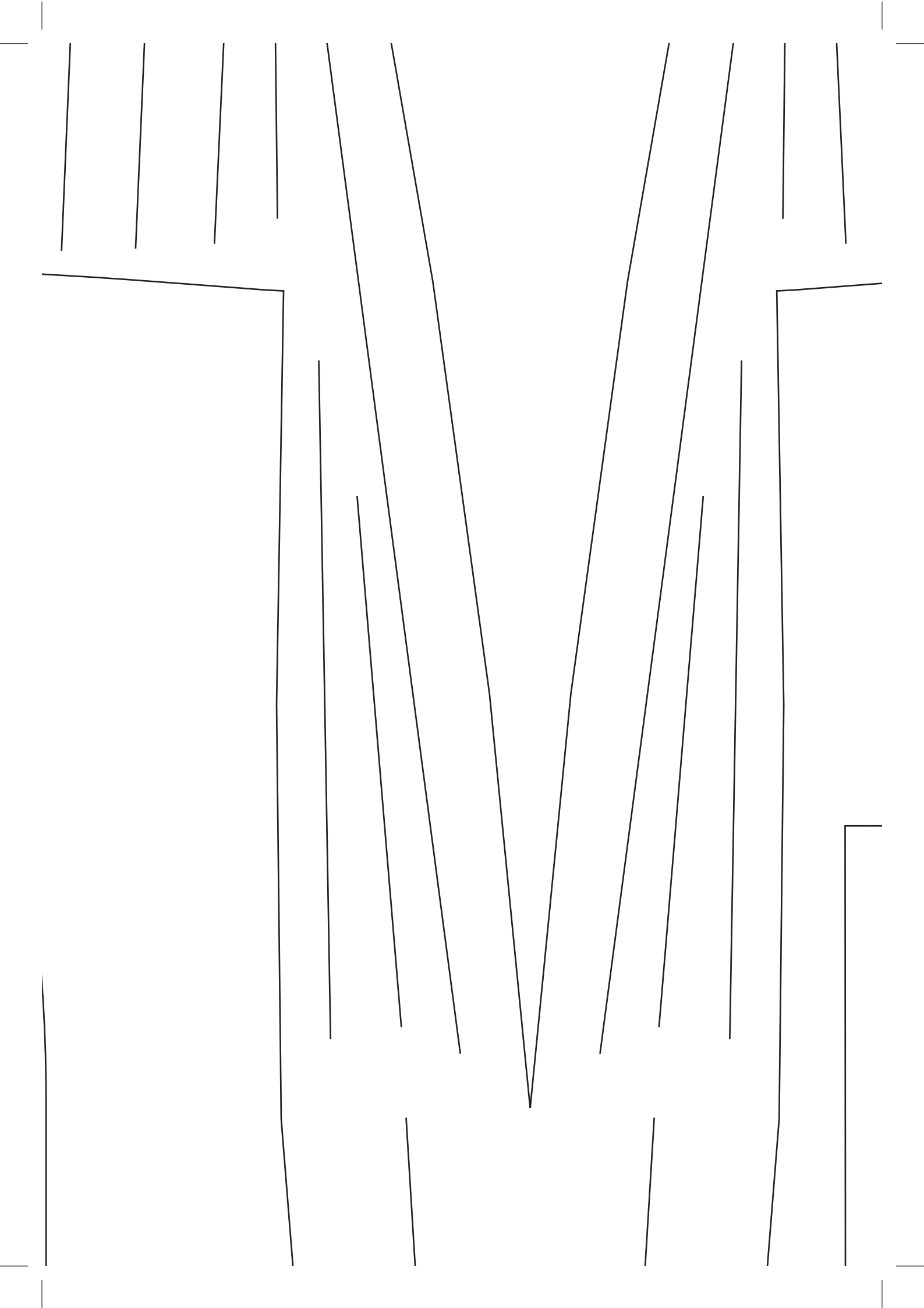

BOX

M B F/A design

scale

1 inch

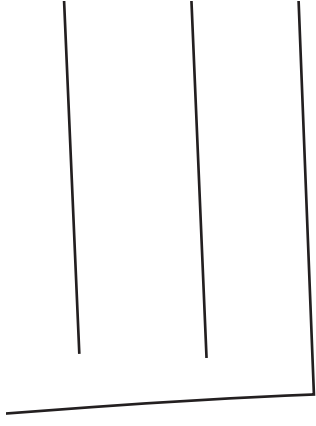

3M

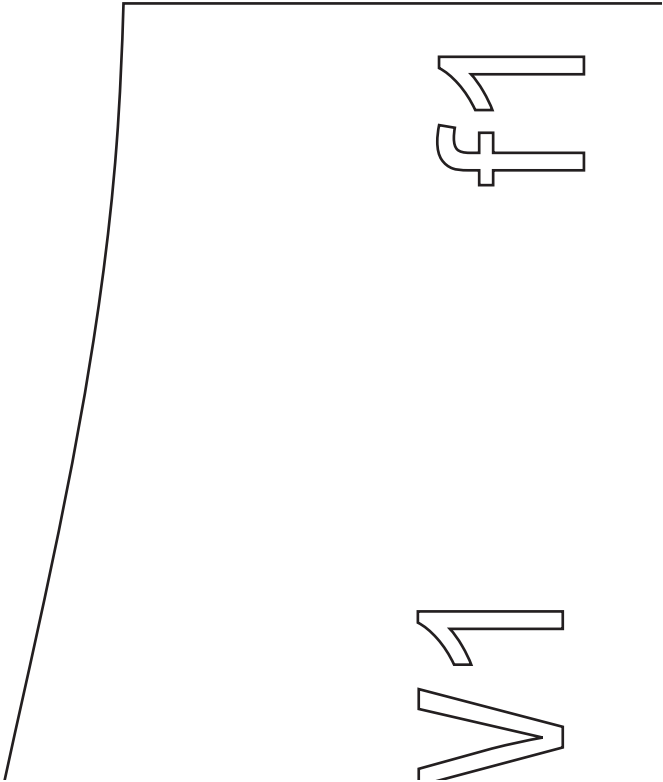
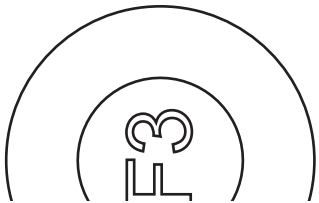
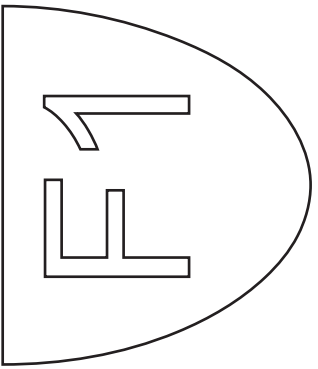
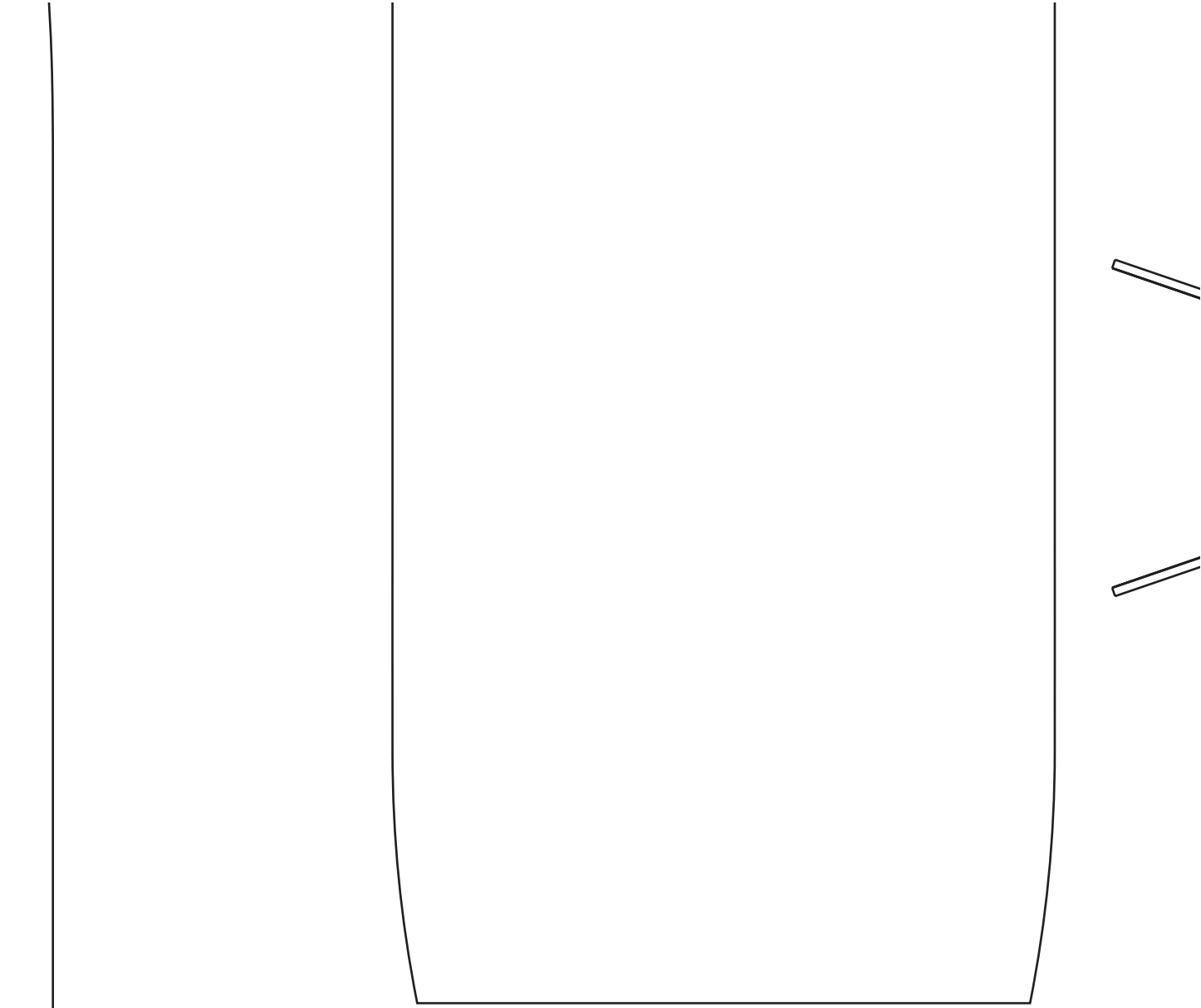

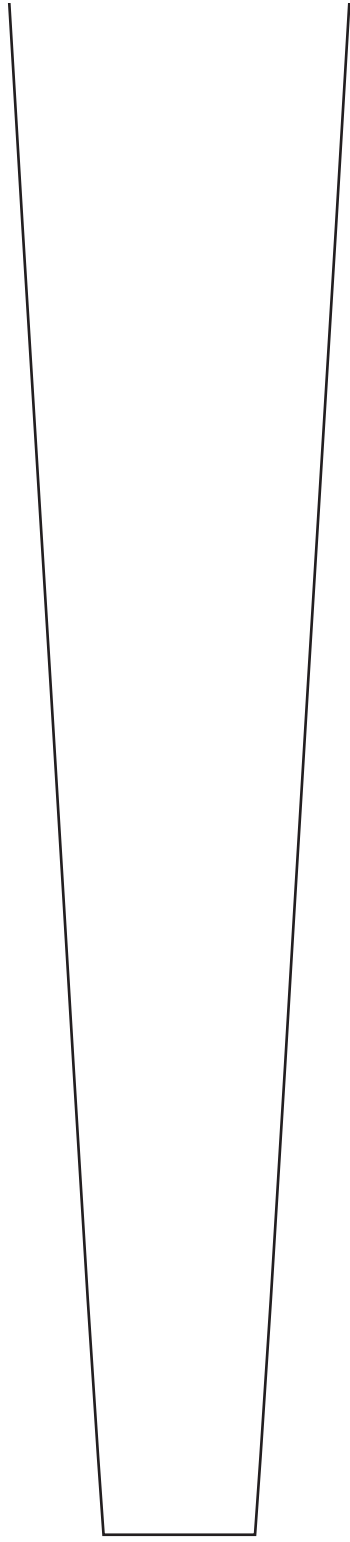
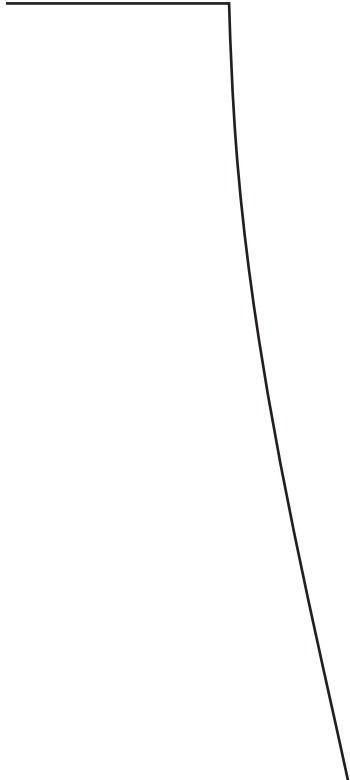
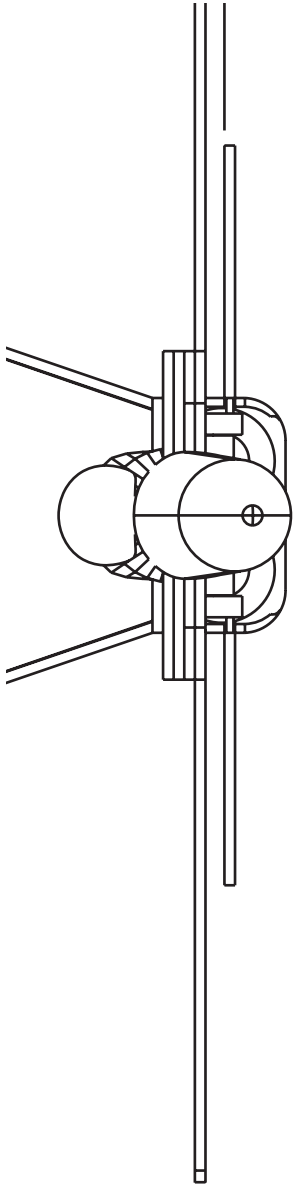

WM4

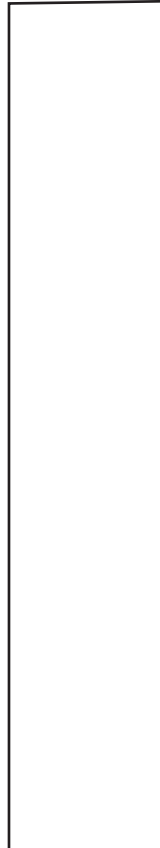

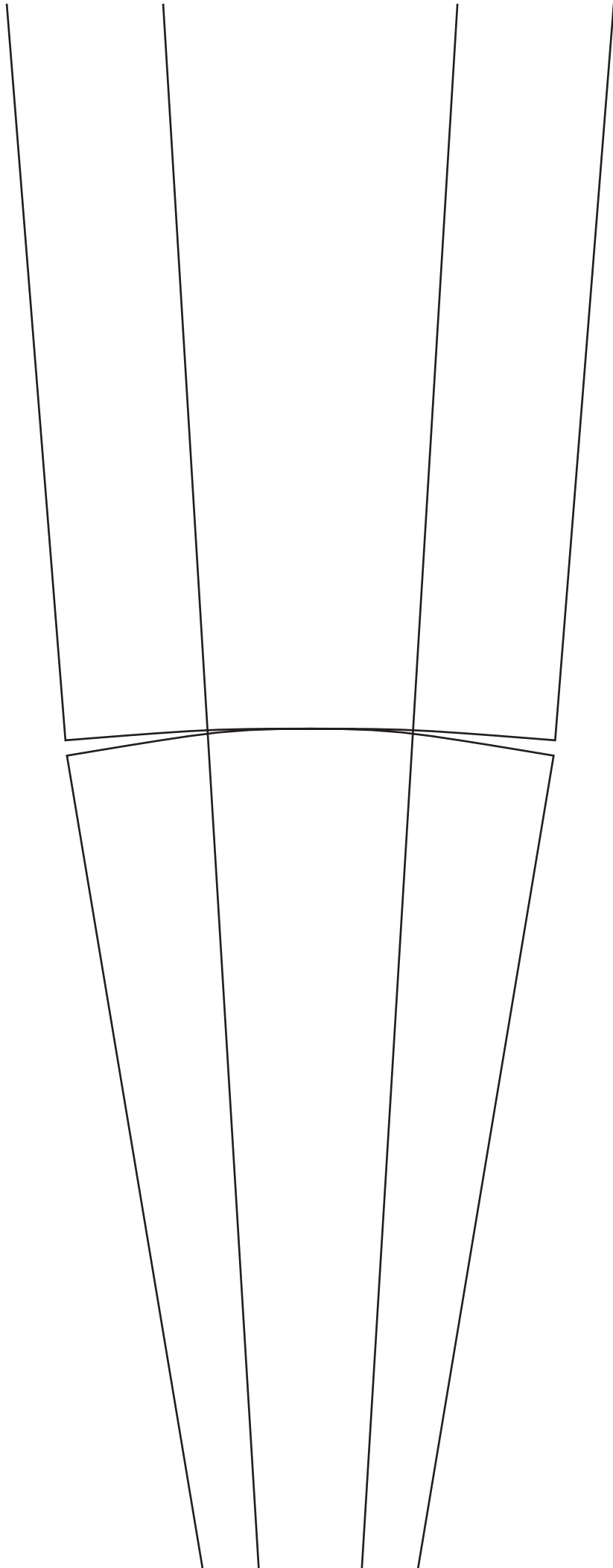
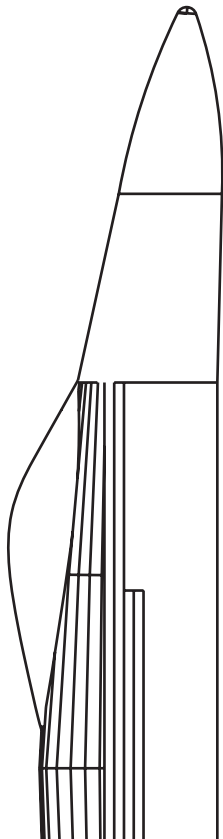

Nacelle A

BOX

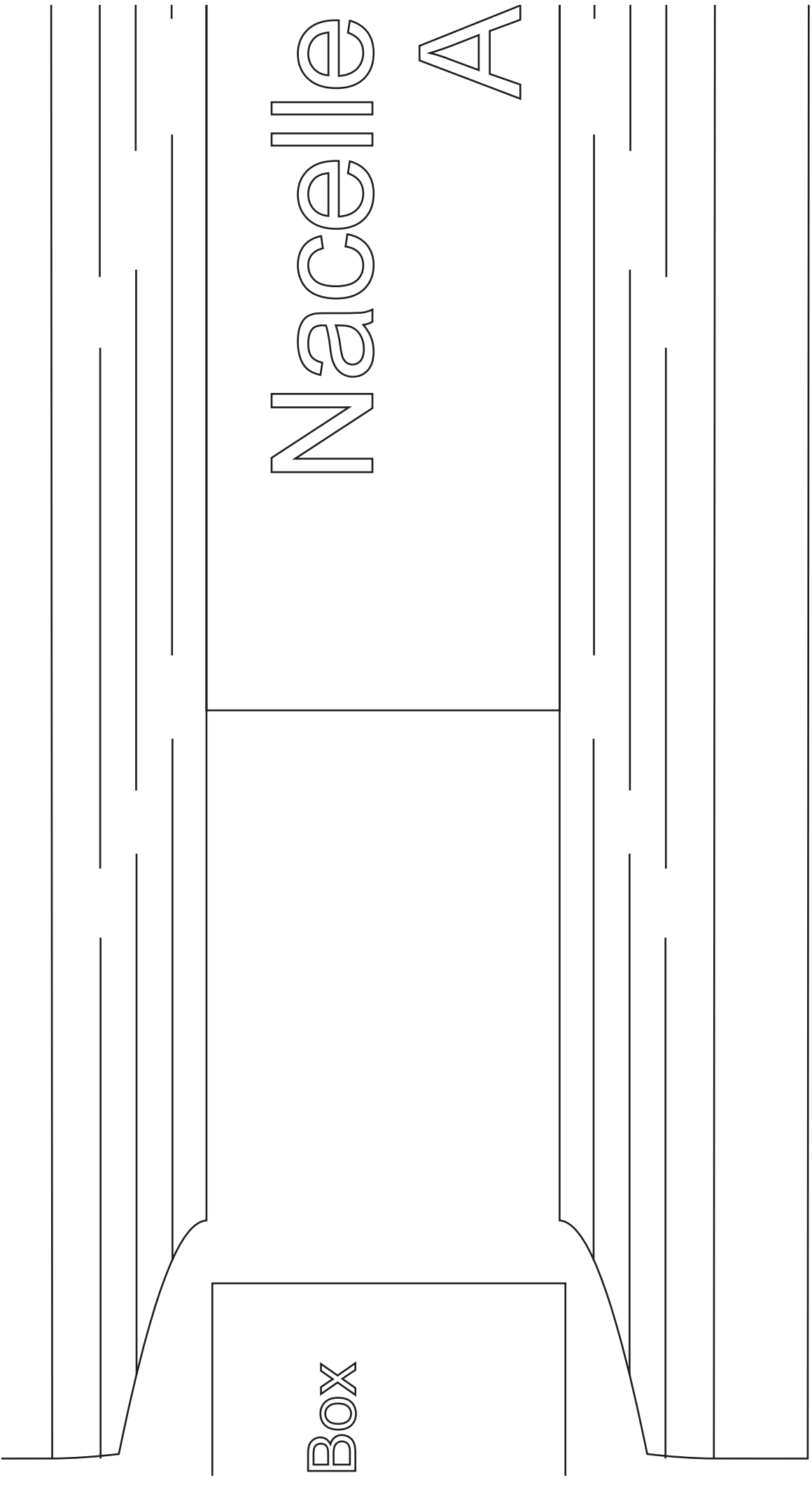

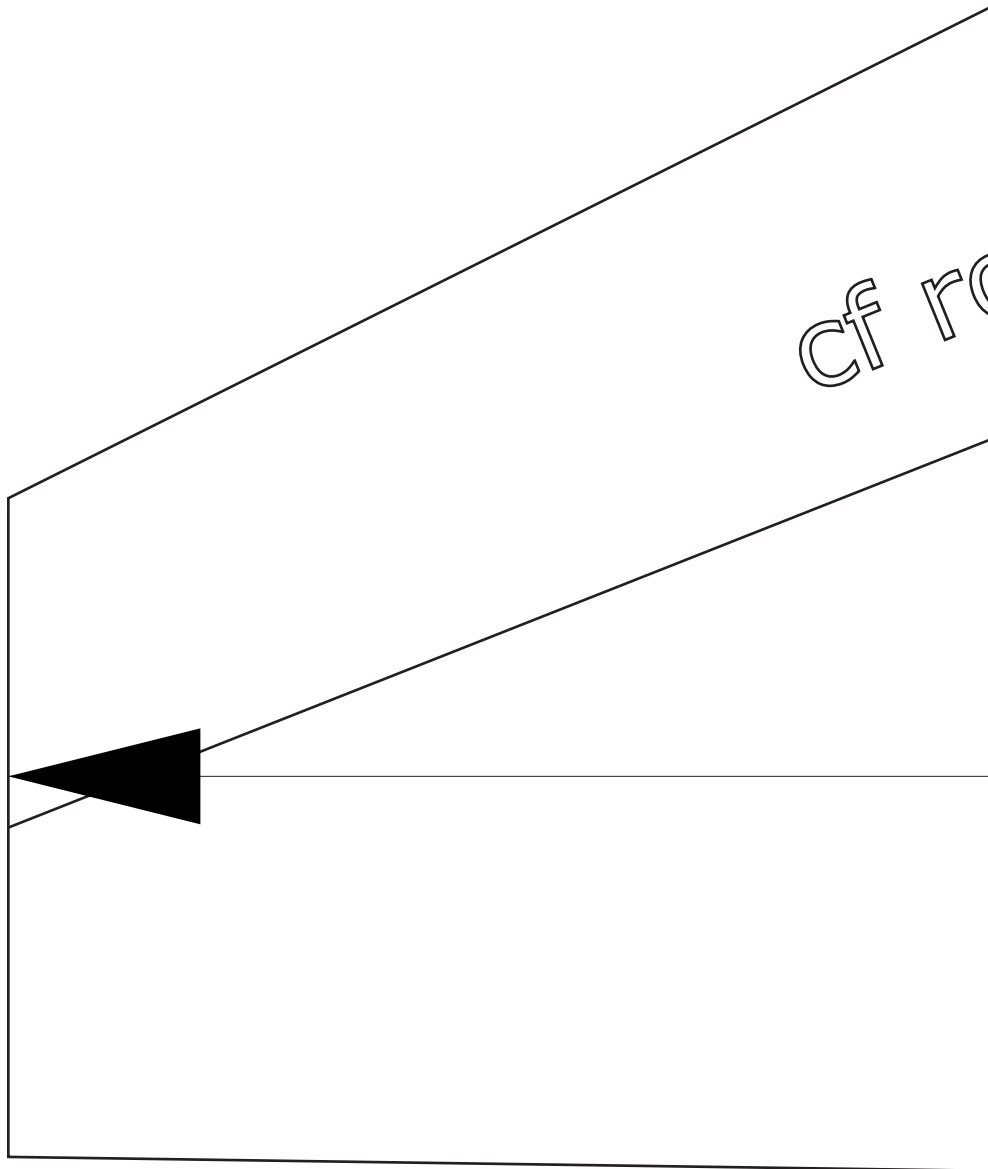
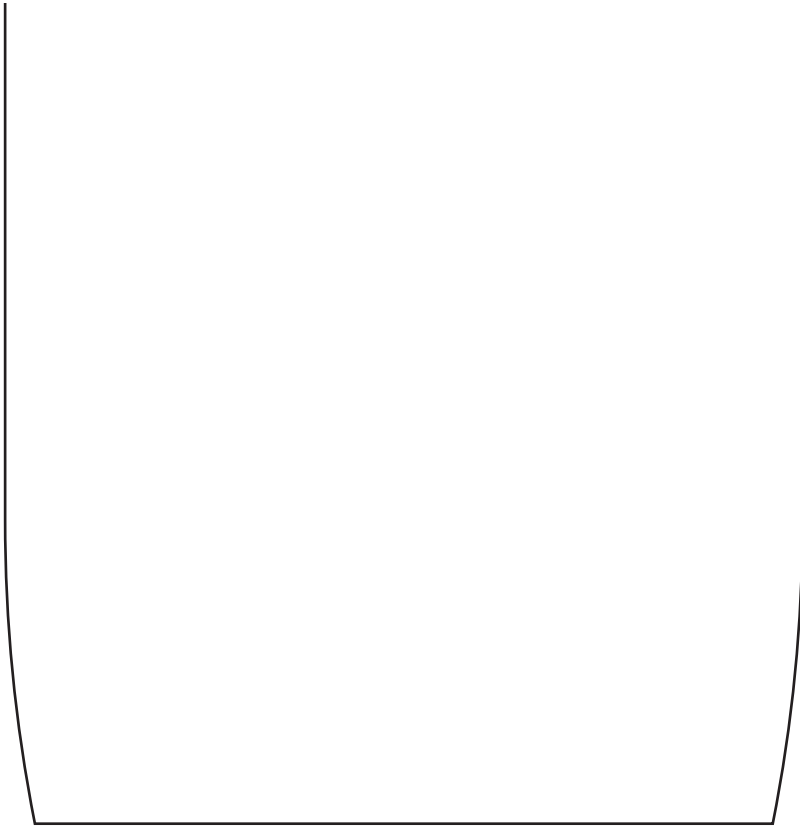

cf re

V

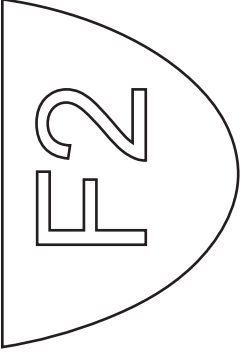
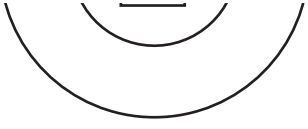

1.5"
-1.62"

servo



od spar

3.60



servo

CF rod spar

2

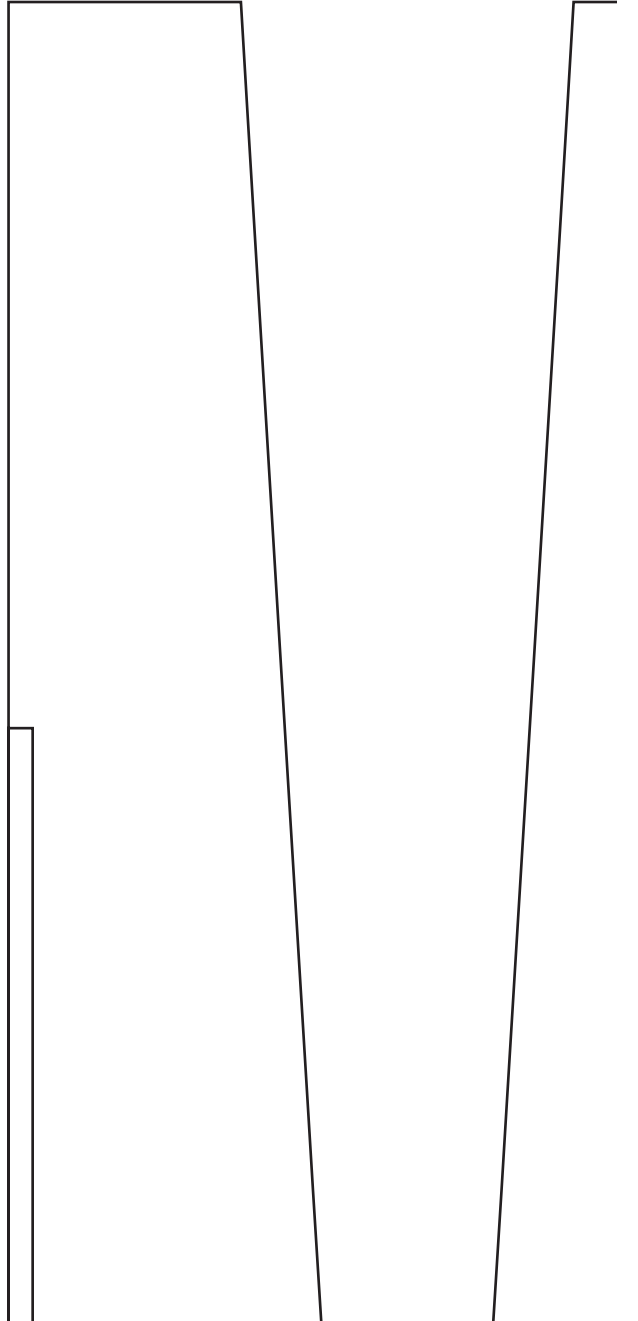
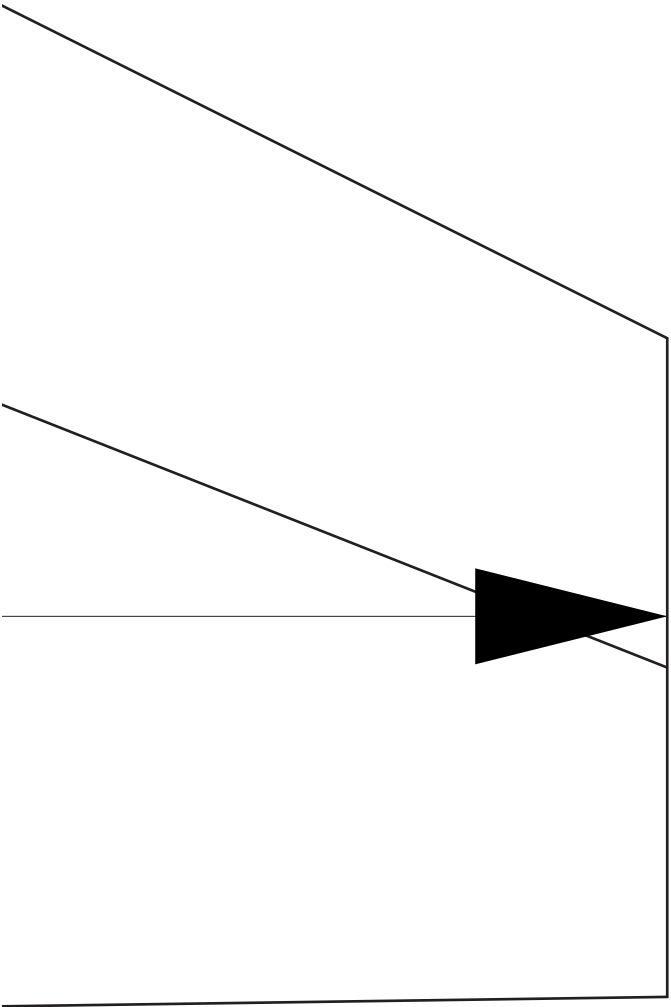
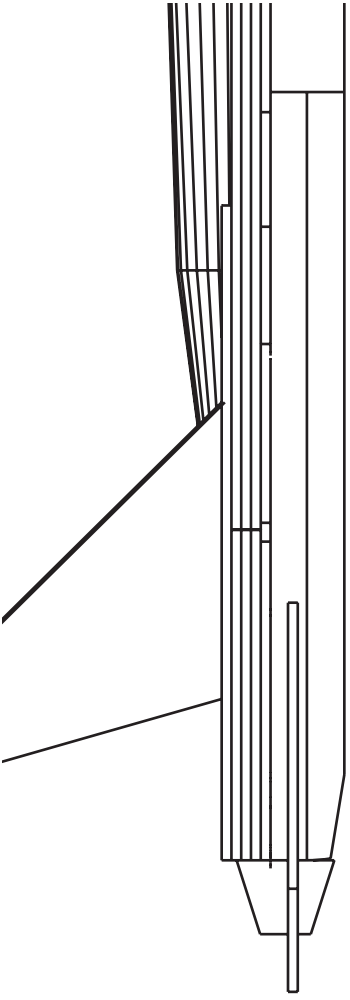
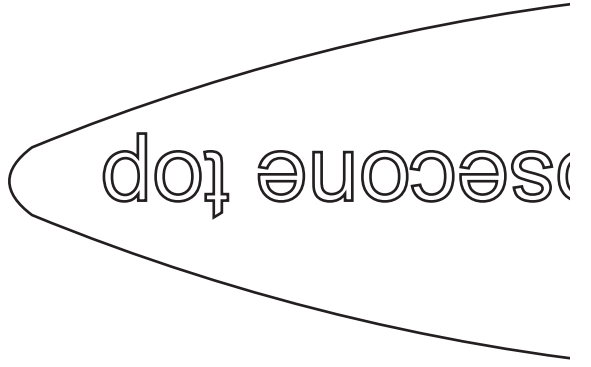
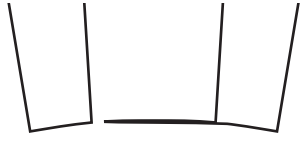

NC

Nacelle

B

Nosecone side

f1

JSR

Rail X2

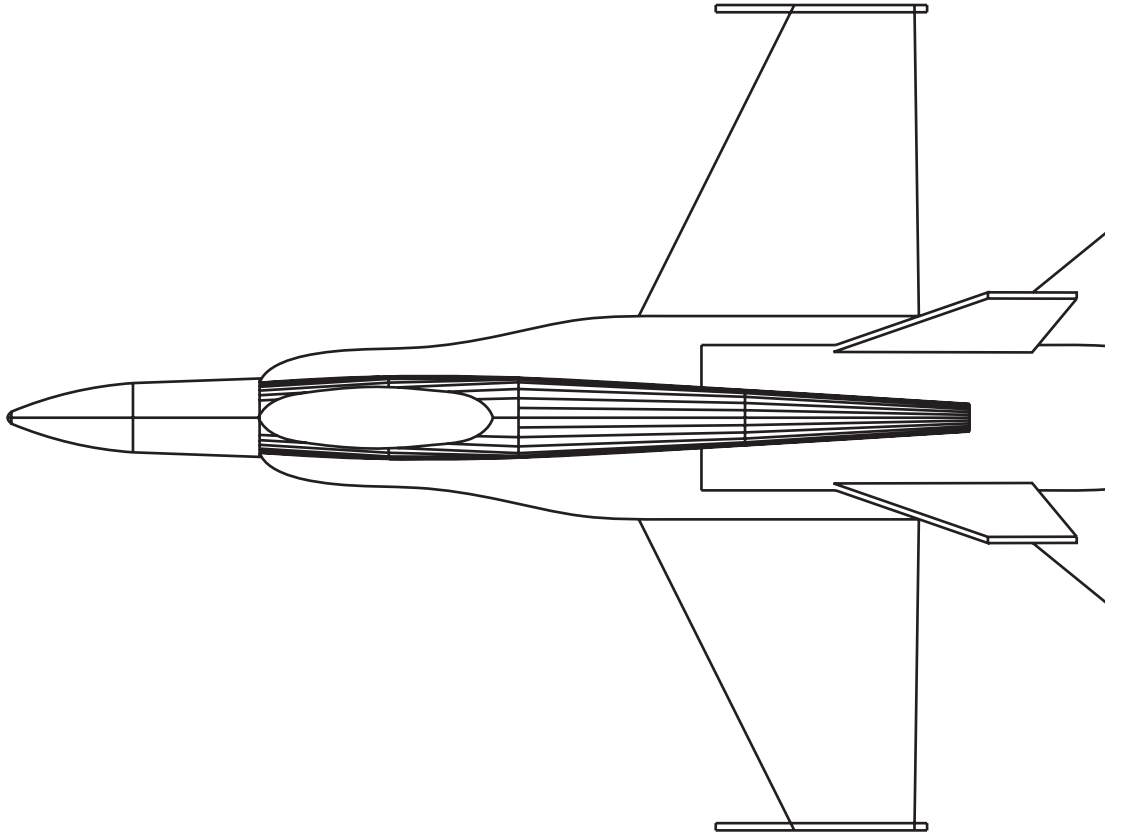

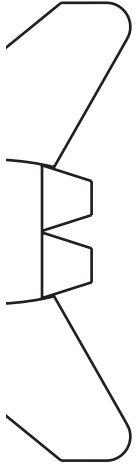

Throws

Pitch: 8" each way

Roll: 1" each way

tab pivot

st

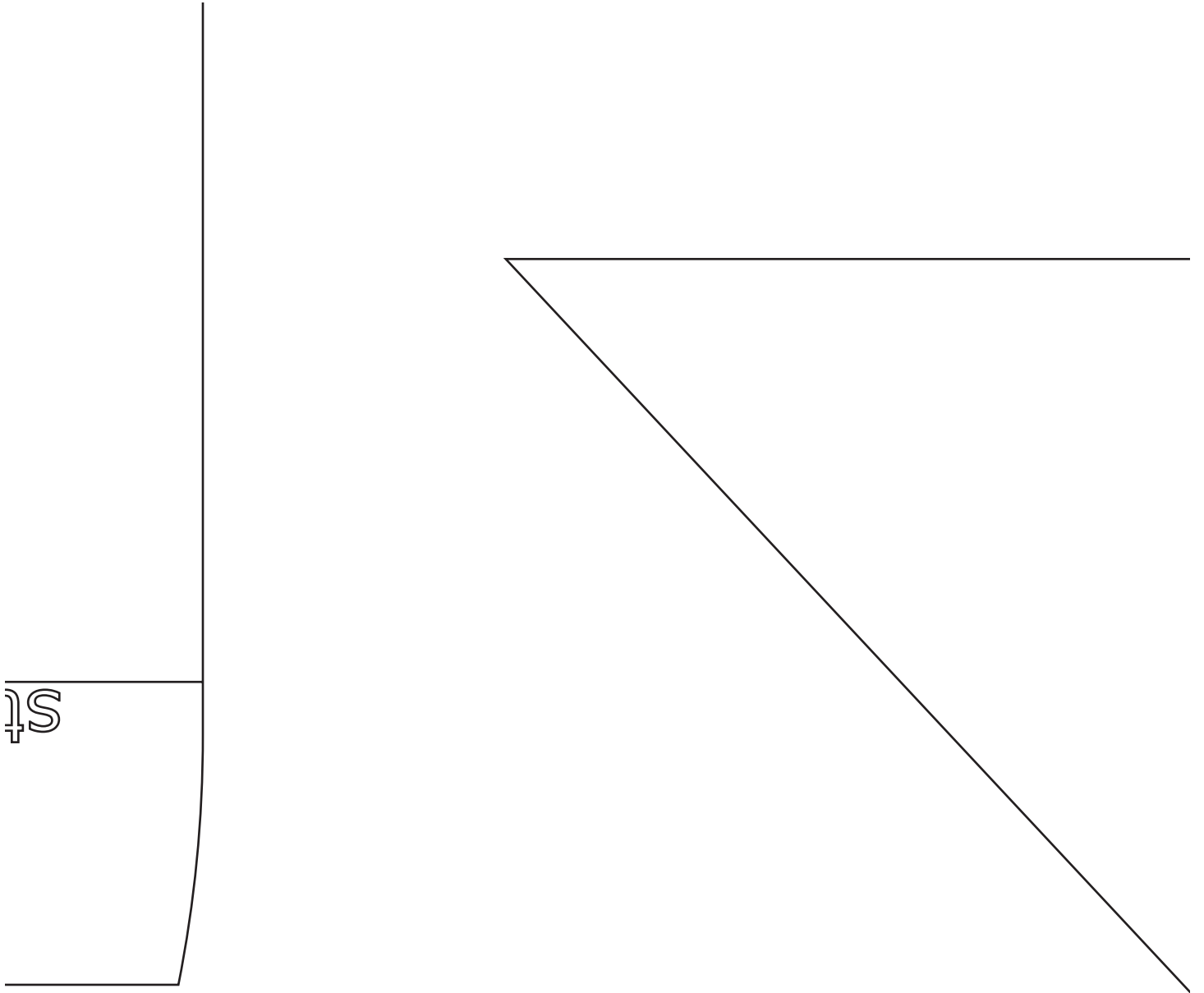

Vert stab

x2

v. stab loc

W5
GM

v. stab loc

f2

LOWFI

Suggested Parts List

Motor: Himax 2015-4100 with gearbox (4.4 gears)

Battery: Thunder Power 1320 mAh 11.1 V lipo

ESC: Castle Creations Phoenix 25

Prop: APC 9x6 Slowflyer

Receiver: Hitec Electron 6

Servos: GWS Pico standard on flaperons, Hitec HS-55 on stabilator

Radio: Futaba 7AC